

MATERIA

ELEGANT . CONCRETE

Elegant Concrete

MATERIA è la nuova collezione che reinterpreta l'essenza del cemento, elevandola ad un linguaggio estetico moderno e raffinato. Ispirata alle lavorazioni artigianali come l'intonaco spatolato a mano, Materia riproduce fedelmente la gestualità e la profondità di superfici realizzate con calce, quarzi e impasti cementizi, trasformandole in un'interpretazione in gres porcellanato dal carattere autentico. Attraverso un attento studio della luce e della materia, la collezione restituisce sottili variazioni di lucentezza, ispirate ai riflessi naturali tipici del quarzo. Le texture evocano rilievi e irregolarità propri delle superfici lavorate a mano, dando vita a strutture visivamente marcate e tattili. MATERIA è caratterizzata da 9 colori attentamente selezionati, che spaziano tra tonalità calde, fredde e colori di tendenza.

Ogni sfumatura è stata pensata per offrire la massima flessibilità creativa, arricchita da elementi decorativi a corredo che conferiscono un carattere unico a qualsiasi ambiente attraverso grafiche, tonalità, texture e una meticolosa cura dei particolari.

MATERIA is the new collection that reinterprets the essence of concrete, elevating it to a modern, refined aesthetic form. Inspired by artisanal procedures such as the hand-trowelled application of plaster, Materia accurately reproduces the crafted texture and depth of surfaces created in lime plaster, quartzes and cement mortars, in a porcelain stoneware version with a truly authentic character.

Meticulous research into light and its interaction with matter has provided the collection with a subtly varied shine inspired by the natural glints of quartz. The uneven relief textures evoke hand-applied surfaces in their tactile, visually "flawed" structures.

MATERIA offers 9 carefully selected colours, embracing warm, cool and trendy tones. Every specific shade is intended to deliver unrivalled creative freedom, extended by decors that give any location a unique personality, through graphic patterning, colour shades, textures and meticulous attention to details.

MATERIA est la nouvelle collection qui réinterprète l'essence du béton en l'élevant à un langage esthétique moderne et raffiné. Inspirée des façonnages artisanaux tels que l'enduit taloché à la main, Materia reproduit fidèlement la gestuelle et la profondeur des surfaces réalisées avec chaux, quartz et pâtes cimentaires, en les transformant en une interprétation en grès cérame au caractère authentique. Grâce à une étude minutieuse de la lumière et de la matière, la collection restitue de subtiles variations de brillance, rappelant les reflets naturels typiques du quartz. Les textures évoquent les reliefs et irrégularités propres aux surfaces façonnées à la main, donnant vie à des structures visuellement marquées et tactiles.

MATERIA se distingue par 9 couleurs soigneusement sélectionnées, allant des tonalités chaudes et froides aux couleurs de tendance. Enrichie de graphismes, teintes, textures et détails méticuleusement soignés, chaque nuance a été formulée pour pousser au maximum la flexibilité créative : autant d'éléments décoratifs qui donnent un caractère unique à chaque espace.

Die neue Kollektion MATERIA interpretiert Beton in einer neuen Designsprache, die ihn auf eine höhere Stufe zeitgemäßer Ästhetik und Raffinesse hebt. Nach dem Vorbild handwerklicher Bearbeitungen, wie beispielsweise per Hand aufgetragener Putz, reproduziert Materia getreu die Struktur und Tiefe von Oberflächen, die mit Mischungen aus Kalk, Quarzsand und Zement hergestellt werden: eine Neuinterpretation in Feinsteinzeug mit authentischem Charakter. Durch sorgfältiges Abwägen der Lichtspiegelung und der Materie kann die Kollektion mit feinen Glanznuancen aufwarten, die die für Quarz typischen natürlichen Reflektionen wiedergeben. Die Texturen vermitteln das reliefartige Aussehen und die Unregelmäßigkeiten, die per Hand bearbeitete Oberflächen kennzeichnen, sodass der Eindruck sichtlich markierter und haptisch auffälliger Strukturen entsteht.

MATERIA verfügt über neun sorgfältig ausgewählte Farbstellungen, die warme, kühle und trendige Nuancen umfassen. Jede Farbstellung wurde für größte gestalterische Freiheit konzipiert und wird durch Dekorelemente bereichert, deren Muster, Nuancen, Texturen und Detailverliebtheit jedem Raum einen einzigartigen Charakter verleihen.



Cuore della materia

The heart of matter
Au cœur de la matière
Herz der materie

Ogni prodotto è stato realizzato con terre nobili a colore per garantire uniformità estetica in tutto lo spessore ed una profondità visiva naturale ed armoniosa. Questa tecnica produttiva garantisce una resistenza maggiore all'usura e allunga il ciclo di vita delle pavimentazioni, oltre a garantire una migliore estetica nelle lavorazioni speciali.

Each product is made from choice quality coloured clays to guarantee the same appearance throughout its thickness and a natural, appealing visual depth. This production technique ensures greater wear resistance and extends floor coverings' lifecycle, as well as guaranteeing a more attractive appearance for specially shaped pieces.

Chaque produit a été fabriqué avec des terres nobles colorées afin de garantir une uniformité esthétique à travers toute l'épaisseur et une profondeur visuelle naturelle et harmonieuse. Cette technique de production augmente la résistance à l'usure et prolonge la durée de vie des revêtements de sol, tout en garantissant une meilleure esthétique pour les façonnages spéciaux.

Alle Artikel der Kollektion bestehen aus edlen farbigen Erden, was für einen visuell einheitlichen Korpus und eine natürliche, harmonische Tiefenoptik sorgt. Diese Herstellungstechnik gewährleistet eine höhere Verschleißbeständigkeit und Standzeit von Bodenbelägen sowie eine wertigere Optik bei Spezialbearbeitungen.



Identità decorativa

Decorative identity
Identité décorative
Dekorative identität

La collezione si completa con decori sabbiati e trame strutturate, studiati per il rivestimento.
Elementi decorativi che interpretano la materia con discrezione e contemporaneità, mantenendo continuità estetica e valorizzando gli spazi con equilibrio e stile.

The collection is completed by sanded decors and structured textures designed for use in wall coverings.
Decorative features that provide a contemporary, understated interpretation of matter, maintaining continuity of look and adding a stylish, tasteful beauty to design schemes.

La collection se complète avec des décors sablés et des trames structurées, conçus pour le revêtement mural.
Des éléments décoratifs qui interprètent la matière avec discrétion et contemporanéité, tout en préservant la continuité esthétique et en valorisant les espaces avec équilibre et style.

Die Kollektion wird durch Sandstrahldekore und markante Texturen ergänzt, die für Wandverkleidungen vorgesehen sind.
Dekorative Elemente interpretieren die Materie auf dezente und moderne Weise; sie bewahren die ästhetische Kontinuität und verleihen den Räumen stilistische Ausgewogenheit.



Mosaici materici

Tactile mosaics
Mosaïques effet matière
Materialbetonte mosaiken

ECO MATERIA 1x1 e 3x3

Argille a colore mischiate con vetri di recupero, prodotti ecologici ad alto contenuto estetico che riescono a valorizzare la profondità delle superfici e migliorare l'armonia degli ambienti. Disponibile anche uno stucco epossidico tono su tono in abbinamento per ogni colore.

LISTELLATO E MINIBAGUETTE 3D

Mosaici a listelli in formato compatto, disponibili in versione piana o tridimensionale. Soluzioni decorative versatili, pensate per arricchire le superfici con ritmo e profondità materica.

ECO MATERIA 1x1 and 3x3

Coloured clays mixed with recycled glass, to create extremely attractive, highly environment-friendly products that emphasise surfaces' depth and bestow harmony on interiors. A matching tone-on-tone epoxy grout is also available for each colour.

LISTELLATO AND MINIBAGUETTE 3D

Strip mosaics in a compact size, available in flat or three-dimensional version. Versatile decorative solutions for bringing rhythm and tactile depth to surfaces.

ECO MATERIA 1x1 et 3x3

Argiles colorées mélangées à des verres recyclés, produits écologiques à haute valeur esthétique qui réussissent à exalter la profondeur des surfaces et à améliorer l'harmonie des espaces. Un mortier époxy ton sur ton est également disponible pour chaque couleur.

LISTELLATO ET MINIBAGUETTE 3D

Mosaïques à listels au format compact, disponibles en version plane ou tridimensionnelle. Des solutions décoratives polyvalentes, conçues pour enrichir les surfaces avec rythme et profondeur de matière.

ECO MATERIA 1x1 und 3x3

Farbige Tonerden im Gemisch mit recyceltem Glas. Die optisch wertigen, nachhaltigen Produkte bringen die Tiefenoptik der Oberflächen zur Geltung und sorgen für eine harmonische Raumatmosphäre. Für jede Farbstellung ist ein Ton in Ton abgestimmter Epoxidharz-Fugenmörtel verfügbar.

LISTELLATO UND MINIBAGUETTE 3D

Stäbchenmosaik im kompakten Format, erhältlich in flacher oder dreidimensionaler Ausführung. Vielseitige dekorative Lösungen ermöglichen eine Bereicherung der Oberflächen durch Rhythmus und materialbetonte Tiefe.

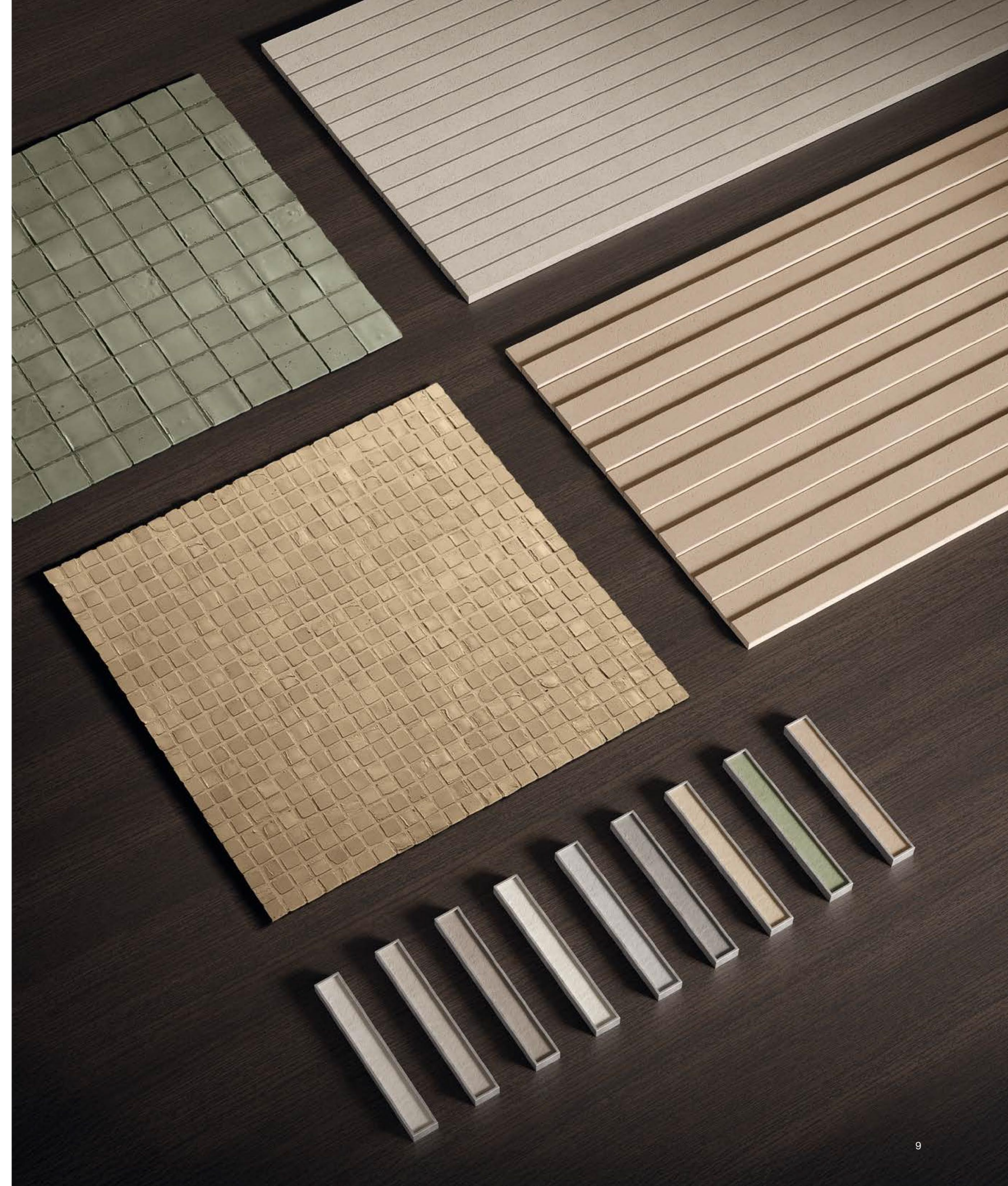

Timeless Elegance

Raffinatezza senza tempo
Refinement beyond the touch of time
Un raffinement intemporel
Zeitlose Raffinesse

Linee pulite e tonalità calde che creano spazi accoglienti,
unendo modernità e delicata eleganza.

Clean lines and warm tones that create
welcoming spaces, combining modernity and
delicate elegance.

Des lignes épurées et des tons chaleureux
qui créent des espaces accueillants, alliant
modernité et élégance délicate.

Klare Linien und warme Töne schaffen
einladende Räume und verbinden Modernität
mit zarter Eleganz.

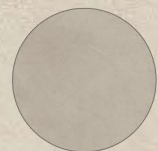
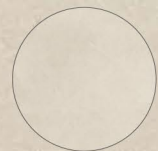

Timeless Elegance

Tra volumi definiti e proporzioni equilibrate, una villa privata immersa nel verde che interpreta l'abitare contemporaneo come espressione di armonia ed equilibrio visivo. Spazi caratterizzati da un'estetica in continuità tra interno ed esterno, dove ogni materiale invita al contatto ed amplifica il senso di quiete. L'atmosfera è avvolgente, costruita con superfici tattili, luce naturale e arredi iconici scelti con misura. Una sintesi progettuale in cui la semplicità si fa eleganza senza tempo.



With its clearly defined volumes and balanced proportions, this private detached home in green surroundings interprets the contemporary lifestyle as an expression of tranquillity and visual harmony. Spaces with an aesthetic that runs seamlessly between indoors and outdoors, where every material is inviting to the touch and amplifies the sense of calm. The irresistible mood of comfort is constructed with tactile surfaces, natural lighting and carefully chosen, iconic furnishings. Immaculate design in which simplicity becomes timeless elegance.

Entre volumes définis et proportions équilibrées, une villa privée immergée dans la verdure qui interprète l'habitat contemporain comme une expression d'harmonie et d'équilibre visuel. Des espaces caractérisés par une esthétique en continuité entre intérieur et extérieur, où chaque matériau invite au contact et amplifie le sentiment de quiétude. L'atmosphère est enveloppante, construite avec des surfaces tactiles, la lumière naturelle et des pièces iconiques choisies avec soin. Une synthèse conceptuelle où la simplicité se transforme en élégance intemporelle.

Definierte Volumen und ausgewogene Proportionen kennzeichnen eine Privatvilla mitten im Grünen, die modernes Wohnen als Ausdruck der Harmonie und visuellen Ausgeglichenheit interpretiert. Auffallend ist die durchgehende Ästhetik zwischen Indoor und Outdoor der Räume, in denen jedes Material zur Berührung einlädt und das Gefühl entspannter Ruhe noch stärker werden lässt. Eine vertrauliche Atmosphäre, die durch haptisch angenehme Oberflächen, natürliches Licht und ikonische, mit Maß ausgesuchte Einrichtungen entsteht. Eine Synthese intelligenter Planung, in der die Einfachheit eine zeitlose Eleganz vermittelt.

WALL: MATERIA Cenere 120x280 - 48"x112" - MATERIA Kalle Strip Led Cenere 60 cm

FLOOR: MATERIA Cenere 2.0 60x120 - 24"x48" **STAIRCASES:** MATERIA Cenere 2.0 **PLANTER:** MATERIA Cenere





WALL: MATERIA Cenere 120x280 - 48"x112" - MATERIA Kalle Strip Led Cenere 120 cm
FLOOR: MATERIA Cenere 2.0 120x120 - 48"x48" **POOL COPING:** MATERIA Cenere 2.0 **POOL:** MATERIA Sandalo

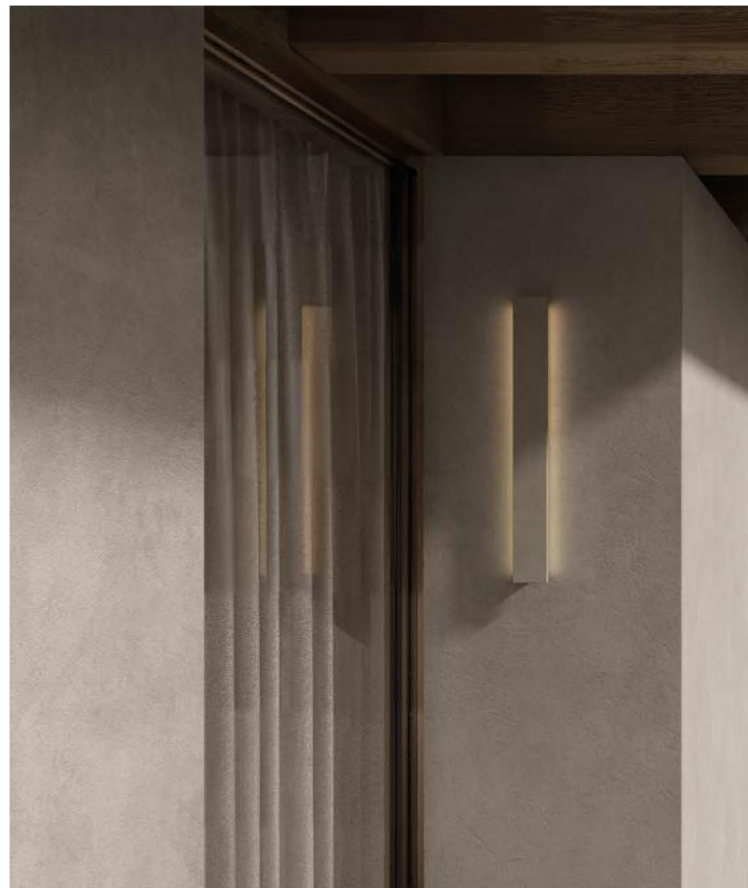

La matericità del cemento si traduce in un linguaggio coerente con il contesto, contribuendo a definire uno spazio esterno essenziale e armonico. La cura dei particolari rafforza il dialogo tra architettura e paesaggio, in un equilibrio silenzioso tra progetto e ambiente.

The textured concrete-effect surface speaks the same language as its context, helping to shape a minimalist yet tasteful outdoor area. Impeccably styled details reinforce the dialogue between architecture and landscape, as design and location merge in a wordless accord.

La matérialité du béton se traduit en un langage cohérent avec le contexte, contribuant à définir un espace extérieur essentiel et harmonieux. Le soin apporté aux détails renforce le dialogue entre architecture et paysage, dans un équilibre silencieux entre projet et environnement.

Der materialbetonte Charakter des Betons findet seinen Ausdruck in einer kontextkohärenten Sprache, die ihren Beitrag zur Definition eines essentiellen und harmonischen Außenambiente leistet. Die sorgfältige Auswahl der Details verstärkt den Dialog zwischen Architektur und Landschaft, der in einer stillen Ausgeglichenheit zwischen Projekt und Umgebung stattfindet.

WALL: MATERIA Cenere 120x280 - 48"x112" - MATERIA Kalle Strip Led Cenere 60 cm
FLOOR: MATERIA Cenere 2.0 60x120 - 24"x48" **STAIRCASES:** MATERIA Cenere 2.0 **PLANTER:** MATERIA Cenere





WALL: MATERIA Cenere 120x280 - 48"x112" - MATERIA Kalle Strip Led Cenere 120 cm **FLOOR:** MATERIA Cenere 2.0 60x120 - 24"x48"
STAIRS: MATERIA Cenere 2.0 **HOT TUB:** NATIVA Lapillo Vena **LOUNGER BASE:** NATIVA Lapillo Vena





WALL: MATERIA Cenere 120x280 - 48"x112" - MATERIA Cenere Hari 120x280 - 48"x112" - MATERIA Kalle Strip Led Cenere 120 cm
FLOOR: MATERIA Cenere 120x120 - 48"x48" **TABLE:** MATERIA Cenere 2.0 - MATERIA Cenere Mini Baguette 3D
UNITS: MATERIA Seta / Cenere / Tortora **VASES K-EDITION AUSTRALE:** K-GEO Seta / K-CATO Cenere / K-SAO Tortora

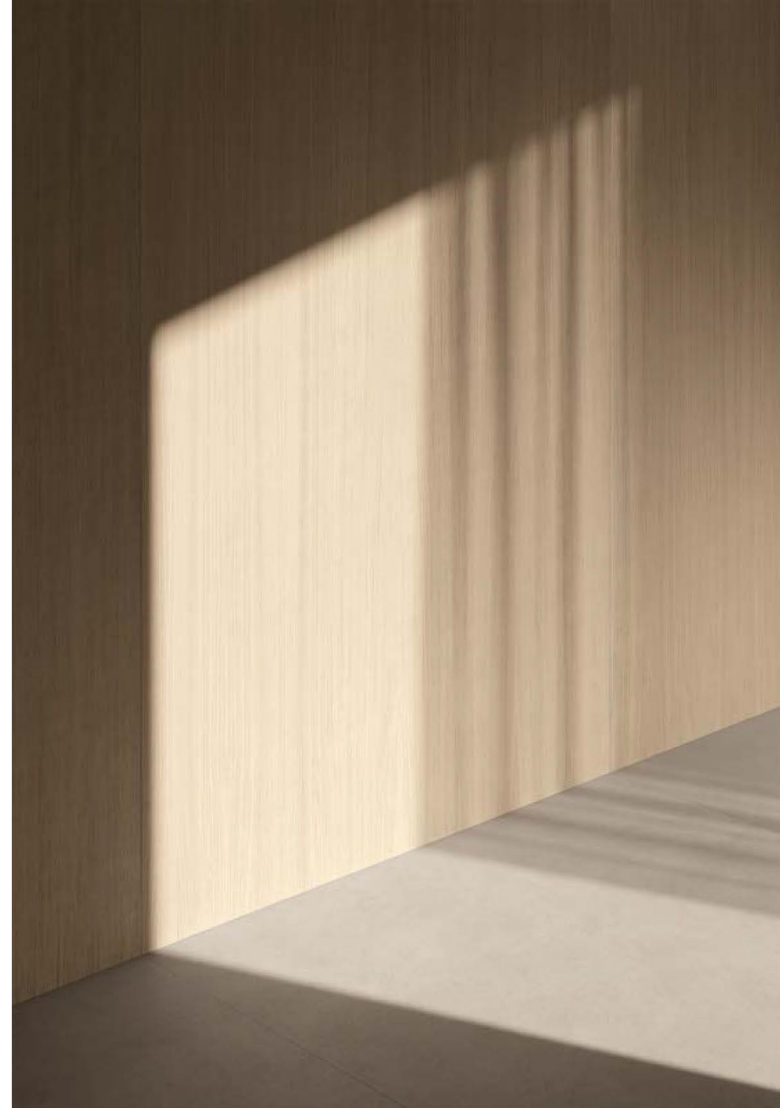

Gli interni si sviluppano in ambienti essenziali e armonici, dove luce naturale e materiali dialogano in equilibrio. Superfici e arredi selezionati con cura definiscono uno spazio misurato e visivamente continuo. Le ampie vetrate proiettano lo sguardo verso l'esterno, mantenendo una connessione coerente con l'insieme.

Indoors, natural lighting and materials tastefully combine in simple yet attractive interiors. Meticulously chosen surfaces and furnishings define an elegant, visually continuous space. The large windows make the outdoor view a constant feature and ensure that the context is always a part of the whole.

Les intérieurs se déploient en des espaces essentiels et harmonieux où la lumière naturelle et les matériaux dialoguent en équilibre. Des surfaces et des éléments d'ameublement soigneusement sélectionnés définissent un espace mesuré et visuellement continu. De larges baies vitrées ouvrent le regard vers l'extérieur, maintenant une connexion cohérente avec l'ensemble.

Die Innenbereiche entwickeln sich in essentielle und harmonische Räume, in denen das natürliche Licht und die Materialien einen ausgeglichenen Dialog miteinander führen. Sorgfältig ausgewählte Oberflächen und Einrichtungen definieren einen maßvoll gestalteten und visuell kontinuierlichen Raum. Die großen Glasfronten führen den Blick nach außen und übernehmen somit die Rolle eines wichtigen Bindeglieds innerhalb der gesamten Struktur.

WALL: MATERIA Cenere 120x280 - 48"x112" - MATERIA Cenere Hari 120x280 - 48"x112"
MATERIA Kalle Strip Led Cenere 120 cm - ESSENCE Pure 120x280 - 48"x112"
FLOOR: MATERIA Cenere 120x120 - 48"x48" **TABLES:** MATERIA Cenere 2.0 - MATERIA Cenere Mini Baguette 3D
UNITS: MATERIA Seta / Cenere / Tortora **VASES K-EDITION AUSTRALE:** K-GEO Seta / K-CATO Cenere / K-SAO Tortora



KITCHEN: MATERIA Seta **KOVER KITCHEN:** MATERIA Seta
FLOOR: MATERIA Tortora 120x120 - 48"x48"

WALL: MATERIA Trama Incenso 60x120 - 24"x48"
FLOOR: MATERIA Tortora 120x120 - 48"x48"
TABLE: MATERIA Seta 2.0 - Listellato Seta





WALL: MATERIA Linova Seta 120x280 - 48"x112"
MATERIA Kalle Strip Led Cenere 90 cm
MIRROR FRAME: MATERIA Seta
FLOOR: MATERIA Seta 60x120 - 24"x48"
WASHBASIN: NATIVA Vena Aurum



WALL: MATERIA Linova Seta 120x280 - 48"x112"
MATERIA Kalle Strip Led Cenere 90 cm
FRAME: MATERIA Seta
FLOOR: MATERIA Seta 60x120 - 24"x48"
WASHBASIN: NATIVA Vena Aurum



BOISERIE: NATIVA Aurum Mini Baguette 3D 30x120 - 12"x48"
CLOSE: MATERIA Seta 6x60 - 2³/₈"x24"
FLOOR: MATERIA Seta 60x120 - 24"x48"



WALL: MATERIA Seta 120x280 - 48"x112"
MATERIA Linova Seta 120x280 - 48"x112"
BATHTUB: NATIVA Vena Aurum
VASE: K-EDITION AUSTRALE K-GEO Seta
UNIT: MATERIA Trama Seta
FLOOR: MATERIA Seta 60x120 - 24"x48"





Una variazione discreta nell'ambiente bagno, dove il colore si inserisce con misura, in dialogo con superfici decorate, luci soffuse e materiali naturali come pietra e legno.

There is a subtle variation in the bathroom, where colour is discreetly added, interacting with decorate surfaces, dim lighting and natural materials like stone and wood.

Une variation discrète dans la salle de bains, où la couleur s'inscrit avec mesure, en dialogue avec des surfaces décorées, des lumières tamisées et des matières naturelles comme la pierre et le bois.

Eine eher unauffällige Variation im Badezimmer, in dem die Farbe maßvoll Einzug hält und den Dialog mit dekorierten Oberflächen, der sanften Beleuchtung und natürlichen Materialien wie Stein und Holz aufnimmt.



WALL: MATERIA Incenso 120x280 - 48"x112" - MATERIA Linova Incenso 60x120 -24"x48" **NICHE:** MATERIA Incenso **SHELF:** MATERIA Tortora
FLOOR: ESSENCE Pure 20x120 - 8"x48" **WASHBASIN:** MATERIA Tortora

New Brutalism

L'essenza della materia

The essence of matter

L'essence de la matière

Das Wesen der Materie

Cemento a vista, geometrie decise e colori freddi per un ambiente essenziale e rigoroso.

Bare concrete, strong geometrical forms and cold colours for a simple, severe ambience.

Des lignes épurées et des tons chaleureux qui créent des espaces accueillants, alliant modernité et élégance délicate.

Klare Linien und warme Töne schaffen einladende Räume und verbinden Modernität mit zarter Eleganz.

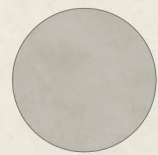

New Brutalism

Una villa contemporanea che traduce il linguaggio brutalista in chiave residenziale, attraverso un'architettura rigorosa e forme scultoree. Il cemento diventa protagonista, superficie viva e mutevole, che dialoga con materiali naturali come legno e acciaio, introdotti con misura per creare contrasti materici. La stessa coerenza si ritrova tra interno ed esterno, in una continuità visiva che rafforza l'essenzialità degli spazi e ne amplifica il carattere autentico.



A contemporary detached home that offers a residential interpretation of Brutalism, with severe architecture and sculpted forms. Concrete plays a central role, its vibrant, changeable surface dialoguing with natural materials like wood and steel, skilfully introduced to create tactile contrasts. The same continuity recurs between indoors and outdoors, with a seamless visual effect that reinforces the project's simplicity and amplifies the sense of authenticity.

Une villa contemporaine qui traduit le langage brutaliste en clé résidentielle, à travers une architecture rigoureuse et des formes sculpturales. Le béton devient le protagoniste, surface vivante et changeante, qui dialogue avec des matériaux naturels comme le bois et l'acier, introduits avec mesure pour créer des contrastes de matière. La même cohérence se retrouve entre intérieur et extérieur, dans une continuité visuelle qui renforce l'essentiel des espaces et amplifie leur caractère authentique.

Eine moderne Villa, in der die Sprache des Brutalismus ihren Ausdruck in einem Wohnprojekt findet, das durch eine strenge Architektur und skulpturhafte Formen gekennzeichnet ist. Der Beton wird zum Protagonisten, zur lebendigen und veränderlichen Oberfläche, die mit natürlichen Materialien wie Holz und Stahl kommuniziert, deren Auswahl mit Augenmaß erfolgte, um materialbetonte Kontraste zu kreieren. Die gleiche Kohärenz ist zwischen Indoor und Outdoor zu beobachten, in einer visuellen Kontinuität, die die Nüchternheit der Räume und ihren authentischen Charakter verstärkt.

WALL: MATERIA Cemento 120x280 - 48"x112" - MATERIA Mini Baguette 3D Cemento 30x120 - 12"x48"
FLOOR: MATERIA Cemento 2.0 120x120 - 48"x48"





WALL: MATERIA Cemento 120x280 - 48"x112" - Mosaico Cemento Mini Baguette 3D 30x120 - 12"x48"
FLOOR: MATERIA Cemento 2.0 120x120 - 48"x48"



WALL: MATERIA Gesso 120x280 - 48"x112" **FLOOR:** MATERIA Cemento 120x120 - 48"x48"
VASE K-EDITION AUSTRALE: K-ESO Pesca



WALL: MATERIA Gesso 120x280 - 48"x112" **FLOOR:** MATERIA Cemento 120x120 - 48"x48"
VASE K-EDITION AUSTRALE: K-ESO Pesca





WALL: MATERIA Sandalo 120x280 - 48"x112" - MATERIA Cemento 120x280 - 48"x112" **FLOOR:** MATERIA Sandalo 120x120 - 48"x48"
KITCHEN: MATERIA Cemento **KOVER KITCHEN:** MATERIA Linova Cemento **SHELF:** MATERIA Cemento



In the heart of the home, the kitchen offers a coherent, characterful expression of New Brutalism. Concrete, deployed in two shades, is completely predominant, appearing on the floors, walls and furniture and in functional features such as the island and sinks. A material that provides a pure, immaculate, contemporary design language.

Au cœur de la maison, la cuisine interprète les codes du New Brutalism avec cohérence et caractère : le béton, décliné en deux tonalités, devient le protagoniste absolu, modelant sols, revêtements muraux, meubles et volumes fonctionnels tels que l'îlot et les évier. Un langage pur, rigoureux et centré sur la matière, contemporain.

Im Herzen des Anwesens interpretiert die Küche die Codes des New Brutalism mit Kohärenz und Charakter: Der in zwei Farbstellungen deklinierte Beton wird zum absoluten Protagonisten, der Böden, Wände, Möbel und funktionale Volumen wie die Kücheninsel und die Waschbecken gestaltet. Eine reine, strenge und zeitgemäße materialbetonte Sprache.

Nel cuore della casa, la cucina interpreta i codici del New Brutalism con coerenza e carattere: il cemento, declinato in due tonalità, diventa protagonista assoluto, plasmando pavimenti, rivestimenti, mobili e volumi funzionali come l'isola e i lavabi. Un linguaggio materico puro, rigoroso e contemporaneo.



WALL: MATERIA Sandalo 120x280 - 48"x112" **FLOOR:** MATERIA Sandalo 120x120 - 48"x48"
KITCHEN: MATERIA Cemento **KOVER KITCHEN:** MATERIA Linova Cemento **SHELF:** MATERIA Cemento



WALL: MATERIA Cemento 120x280 - 48"x112" - MATERIA Trama Cemento 60x120 - 24"x48" **FLOOR:** MATERIA Cemento 60x60 - 24"x24"
WASHBASIN: MATERIA Cemento - MATERIA Trama Cemento **NICHE:** MATERIA Cemento



WALL: MATERIA Cemento 120x280 - 48"x112" - MATERIA Trama Cemento 60x120 - 24"x48"
WASHBASIN: MATERIA Cemento / MATERIA Trama Cemento

WALL: MATERIA Trama Cemento 60x120 - 24"x48" **FLOOR:** MATERIA Cemento 60x60 - 24"x24"
BATHROOM FURNITURE: Pillar MATERIA Cemento

Natural Japandi

Armonia Naturale
Natural harmony
Harmonie Naturelle
Natürliche Harmonie

Superfici sobrie e colori di tendenza che fondono estetica giapponese e scandinava in un equilibrio armonioso.

Understated surfaces and trendy colours that merge Japanese and Scandinavian aesthetics in a tasteful balance.

Des surfaces sobres et des couleurs tendance qui mélangent les esthétiques japonaises et scandinaves dans un équilibre harmonieux.

Schlichte Oberflächen und trendige Farben, die japanische und skandinavische Ästhetik in harmonischer Balance verbinden.



Natural Japandi

Un resort&spa immerso nella vegetazione mediterranea, a pochi passi dal mare, dove l'architettura dialoga con il paesaggio in un equilibrio naturale. Volumi essenziali, materiali autentici e colori ispirati alla terra creano spazi che invitano a rallentare, alla cura di sé e ad una nuova idea di benessere. Un progetto in cui la sobrietà estetica incontra la quiete dello spirito.



A resort & spa immersed in Mediterranean vegetation, a short stroll from the sea, where the architecture dialogues with the landscape in a natural equilibrium. Simple forms, authentic materials and earthy colours create spaces that extend an invitation to slow down, take care of yourself and embrace a new idea of wellbeing. A project where an understated aesthetic brings calm to the soul.

Un resort & spa immergé dans la végétation méditerranéenne, à quelques pas de la mer, où l'architecture dialogue avec le paysage dans un équilibre naturel. Des volumes essentiels, des matériaux authentiques et des couleurs inspirées par la terre créent des espaces qui invitent à ralentir, à prendre soin de soi et à vivre une nouvelle idée de bien-être. Un projet où la sobriété esthétique rencontre la quiétude de l'esprit.

Ein Resort&Spa inmitten mediterraner Vegetation, nur wenige Schritte vom Meer entfernt, wo die Architektur in natürlicher Ausgewogenheit den Dialog mit der Landschaft aufnimmt. Essentielle Volumen, authentische Materialien und erdige Farbtöne kreieren Räume, die dazu einladen, den Rhythmus zu verlangsamen, Körper und Geist zu pflegen und eine neue Idee des Wohlbefindens auszuleben. Ein Projekt, in dem die ästhetische Nüchternheit auf die Ruhe des Geistes trifft.

WALL: MATERIA Tortora 120x280 - 48"x112" **FLOOR:** Tortora 2.0 120x120 - 48"x48"
PATH LIGHTS: MATERIA Tortora





WALL: MATERIA Tortora 120x280 - 48"x112" SHOWER WALL: MATERIA Oliva 120x280 - 48"x112" FLOOR: MATERIA Tortora 2.0 120x120 - 48"x48"
POOL: MATERIA Tortora PLANTER: MATERIA Tortora 2.0 LOUNGER BASE: ESSENCE Ambre TABLES: MATERIA Cenere



Gli spazi esterni e l'ampia piscina si inseriscono con naturalezza nel paesaggio, in un equilibrio attento tra forme, materiali e vegetazione. Ogni dettaglio – dai bordi su misura agli arredi integrati – restituisce un'idea di cura silenziosa, trasformando l'area all'aperto in uno spazio di armonia e contemplazione.

The outdoor areas and large swimming pool fit naturally into the landscape, with a beautifully chosen mix of forms, materials and vegetation. Every detail – from the bespoke edges to the built-in furnishings – inspires an idea of silent care, transforming the outdoor area into a place of harmony and contemplation.

Les espaces extérieurs et la vaste piscine s'intègrent avec naturel dans le paysage, dans un équilibre subtil entre formes, matériaux et végétation. Chaque détail – des bords sur mesure aux aménagements intégrés – exprime une idée de soin discret, transformant l'espace extérieur en un lieu d'harmonie et de contemplation.

Die Außenbereiche und der große Swimmingpool fügen sich auf natürliche Weise in die Landschaft ein; es entsteht ein harmonisches Gleichgewicht zwischen Formen, Materialien und Vegetation. Jedes Detail – von den maßgeschneiderten Beckenrändern bis hin zu den integrierten Einrichtungen – vermittelt die Idee einer geräuschlosen Sorgfalt, die den Außenbereich in einen Raum der Harmonie und Kontemplation verwandelt.



FLOOR: MATERIA Tortora 2.0 120x120 - 48"x48"
PLANTERS: MATERIA Tortora 2.0 **BASE:** ESSENCE Ambre



Gli spazi comuni accolgono gli ospiti in ambienti silenziosi e curati, dove materiali naturali, arredi su misura e dettagli scultorei definiscono un'estetica equilibrata e coerente.

Un percorso visivo fatto di forme essenziali e texture raffinate che accompagna verso le suite, anticipandone l'atmosfera raccolta e i richiami alla natura.

The communal areas welcome guests with immaculate, quiet interiors, where natural materials, bespoke furnishings and sculpted details create a balanced, coherent aesthetic. A visual sequence of simple forms and exquisite textures leads to the suites, with a foretaste of their intimate mood and natural touches.

Les espaces communs accueillent les clients dans des environnements silencieux et soignés, où matériaux naturels, mobilier sur mesure et détails sculpturaux définissent une esthétique équilibrée et cohérente. Un parcours visuel fait de formes essentielles et de textures raffinées conduit vers les suites, en anticipant leur atmosphère intime et leurs rappels à la nature.

Die Allgemeinbereiche präsentieren sich den Gästen als ruhige und gepflegte Räume, in denen natürliche Materialien, maßgeschneiderte Einrichtungen und skulpturhafte Details eine ausgewogene und kohärente Ästhetik definieren. Ein visueller Parcours aus essentiellen Formen und raffinierten Texturen, der zu den Suiten führt und dabei deren friedliche Atmosphäre und die Verweise auf die Natur vorwegnimmt.



WALL: MATERIA Oliva 120x280 - 48"x112" - MATERIA Edelis Oliva 120x280 - 48"x112" - MATERIA Kalle Strip Led Oliva 60 cm
FLOOR: ESSENCE Ambre 26,5x180 - 10 1/2"x72" **OUTDOOR FLOOR:** MATERIA Tortora 2.0 120x120 - 48"x48"
PLANTERS: Tortora 2.0 **LOUNGER BASE:** ESSENCE Ambre **WASHBASIN:** MATERIA Pesca



WALL: MATERIA Oliva 120x280 - 48"x112"
ECO MATERIA Mosaico 3x3 Oliva 30x30 - 12"x12"
FLOOR: ECO MATERIA Mosaico 3x3 Oliva 30x30 - 12"x12"
NICHE: MATERIA Oliva **BENCH:** MATERIA Oliva



WALL: MATERIA Oliva 120x280 - 48"x112"
 MATERIA Edelis Oliva 120x280 - 48"x112"
FLOOR: ESSENCE Ambre 26,5x180 - 10 1/2"x72"
OUTDOOR FLOOR: MATERIA Tortora 2.0 120x120 - 48"x48"
WASHBASIN: MATERIA Pesca
PLANTER: Tortora 2.0 **NICHE:** MATERIA Oliva



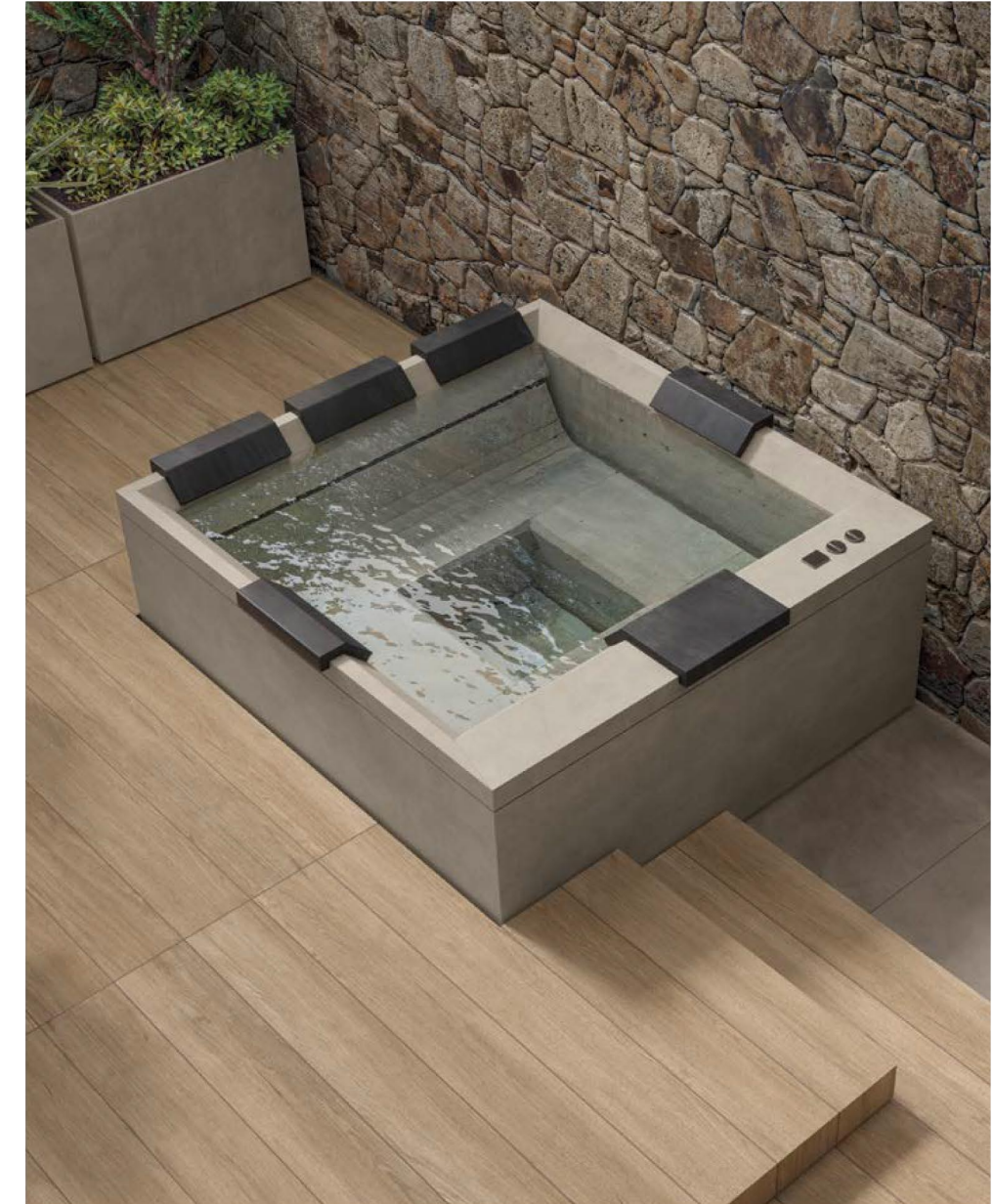

WALL: MATERIA Tortora 120x280 - 48"x112" **FLOOR:** MATERIA Tortora 2.0 120x120 - 48"x48" - ESSENCE Ambre Deck 2.0 26,5x180 - 10 1/2"x72"
HOT POOL: MATERIA Tortora **PLANTERS:** MATERIA Tortora 2.0



WALL: MATERIA Pesca 120x280 - 48"x112" - MATERIA Pesca Mini Baguette 3D 30x120 - 12"x48" **CLOSE:** MATERIA Pesca 6x60 - 2³/₈"x24"
FLOOR: MATERIA Tortora Grip 60x120 - 24"x48" **BENCH:** MATERIA Pesca



WALL: MATERIA Pesca 120x280 - 48"x112" - MATERIA Edelis Pesca 120x280 - 48"x112" - ECO MATERIA Mosaico 1x1 Pesca 30x30 - 12"x12"
FLOOR: MATERIA Tortora 60x60 - 24"x24" - ECO MATERIA Mosaico 1x1 Pesca 30x30 - 12"x12"

Un luogo di rigenerazione profonda, dove ogni spazio è pensato per favorire la cura del corpo e dello spirito. Linee minimaliste, luci morbide e superfici materiche definiscono un ambiente raccolto e contemplativo. Colori tenui e rassicuranti accompagnano il visitatore in un percorso sensoriale che alterna acqua, silenzio e relax, in piena continuità con l'identità estetica del progetto.

WALL: MATERIA Pesca 120x280 - 48"x112" - ECO MATERIA Mosaico 1x1 Oliva 30x30 - 12"x12"
FLOOR: MATERIA Tortora Grip 60x120 - 24"x48" **UNIT:** MATERIA Oliva



A place of profound regeneration, where every space is carefully designed to care for the body and spirit. Minimalist lines, soft lighting and tactile surfaces create an intimate, contemplative ambience. Delicate, reassuring colours guide the visitor in a sensory experience that alternates water, silence and relaxation, in complete coherence with the project's aesthetic identity.

Un lieu de régénération profonde, où chaque espace est conçu pour favoriser le soin du corps et de l'esprit. Des lignes minimalistes, des lumières suaves et des surfaces à effet de matière définissent un environnement intime et contemplatif. Des couleurs douces et rassurantes accompagnent le visiteur dans un parcours sensoriel alternant eau, silence et détente, en parfaite continuité avec l'identité esthétique du projet.

Ein Ort zur echten Regeneration, wo jeder Raum zur nachhaltigen Pflege von Körper und Geist beiträgt. Minimalistische Linien, sanfte Beleuchtung und materialbetonte Oberflächen definieren ein friedliches und kontemplatives Ambiente. Dezent und beruhigende Farben begleiten den Besucher auf einem für die Sinne anmutsvollen Weg, auf dem Wasser, Ruhe und Relax Hand in Hand gehen und eine gemeinsame Linie mit der ästhetischen Identität des Projekts bilden.

WALL: MATERIA Oliva 120x280 - 48"x112" **FLOOR:** MATERIA Tortora Grip 60x120 - 24"x48"
LOUNGER: ECO MATERIA Mosaico 1x1 Oliva 30x30 - 12"x12"



SETA

6 mm

- 120x280** - 48"x112"
- 120x120** - 48"x48"
- 60x120** - 24"x48"

9 mm

- 120x120** - 48"x48"
- 120x120** - 48"x48" Grip
- 60x120** - 24"x48"
- 60x120** - 24"x48" Grip
- 80x80** - 32"x32"
- 80x80** - 32"x32" Grip
- 60x60** - 24"x24"

SKE2.0

20 mm

- 120x120** - 48"x48"
- 60x120** - 24"x48"

CENERE

6 mm

- 120x280** - 48"x112"
- 120x120** - 48"x48"
- 60x120** - 24"x48"

9 mm

- 120x120** - 48"x48"
- 120x120** - 48"x48" Grip
- 60x120** - 24"x48"
- 60x120** - 24"x48" Grip
- 80x80** - 32"x32"
- 80x80** - 32"x32" Grip
- 60x60** - 24"x24"

SKE2.0

20 mm

- 120x120** - 48"x48"
- 60x120** - 24"x48"

TORTORA

6 mm

- 120x280** - 48"x112"
- 120x120** - 48"x48"
- 60x120** - 24"x48"

9 mm

- 120x120** - 48"x48"
- 120x120** - 48"x48" Grip
- 60x120** - 24"x48"
- 60x120** - 24"x48" Grip
- 80x80** - 32"x32"
- 80x80** - 32"x32" Grip
- 60x60** - 24"x24"

SKE2.0

20 mm

- 120x120** - 48"x48"
- 60x120** - 24"x48"



GESSO

6 mm

- 120x280** - 48"x112"
- 120x120** - 48"x48"
- 60x120** - 24"x48"

9 mm

- 120x120** - 48"x48"
- 120x120** - 48"x48" Grip
- 60x120** - 24"x48"
- 60x120** - 24"x48" Grip
- 80x80** - 32"x32"
- 80x80** - 32"x32" Grip
- 60x60** - 24"x24"

SKE2.0

20 mm

- 120x120** - 48"x48"
- 60x120** - 24"x48"

CEMENTO

6 mm

- 120x280** - 48"x112"
- 120x120** - 48"x48"
- 60x120** - 24"x48"

9 mm

- 120x120** - 48"x48"
- 120x120** - 48"x48" Grip
- 60x120** - 24"x48"
- 60x120** - 24"x48" Grip
- 80x80** - 32"x32"
- 80x80** - 32"x32" Grip
- 60x60** - 24"x24"

SKE2.0

20 mm

- 120x120** - 48"x48"
- 60x120** - 24"x48"

SANDALO

6 mm

- 120x280** - 48"x112"
- 120x120** - 48"x48"
- 60x120** - 24"x48"

9 mm

- 120x120** - 48"x48"
- 120x120** - 48"x48" Grip
- 60x120** - 24"x48"
- 60x120** - 24"x48" Grip
- 80x80** - 32"x32"
- 80x80** - 32"x32" Grip
- 60x60** - 24"x24"

SKE2.0

20 mm

- 120x120** - 48"x48"
- 60x120** - 24"x48"



PESCA

6 mm

120x280 - 48"x112"

120x120 - 48"x48"

60x120 - 24"x48"

9 mm

60x120 - 24"x48"

OLIVA

6 mm

120x280 - 48"x112"

120x120 - 48"x48"

60x120 - 24"x48"

9 mm

60x120 - 24"x48"

INCENSO

6 mm

120x280 - 48"x112"

120x120 - 48"x48"

60x120 - 24"x48"

9 mm

60x120 - 24"x48"

MATERIA

ELEGANT . CONCRETE

TRAMA

9 mm

60x120 - 24"x48"



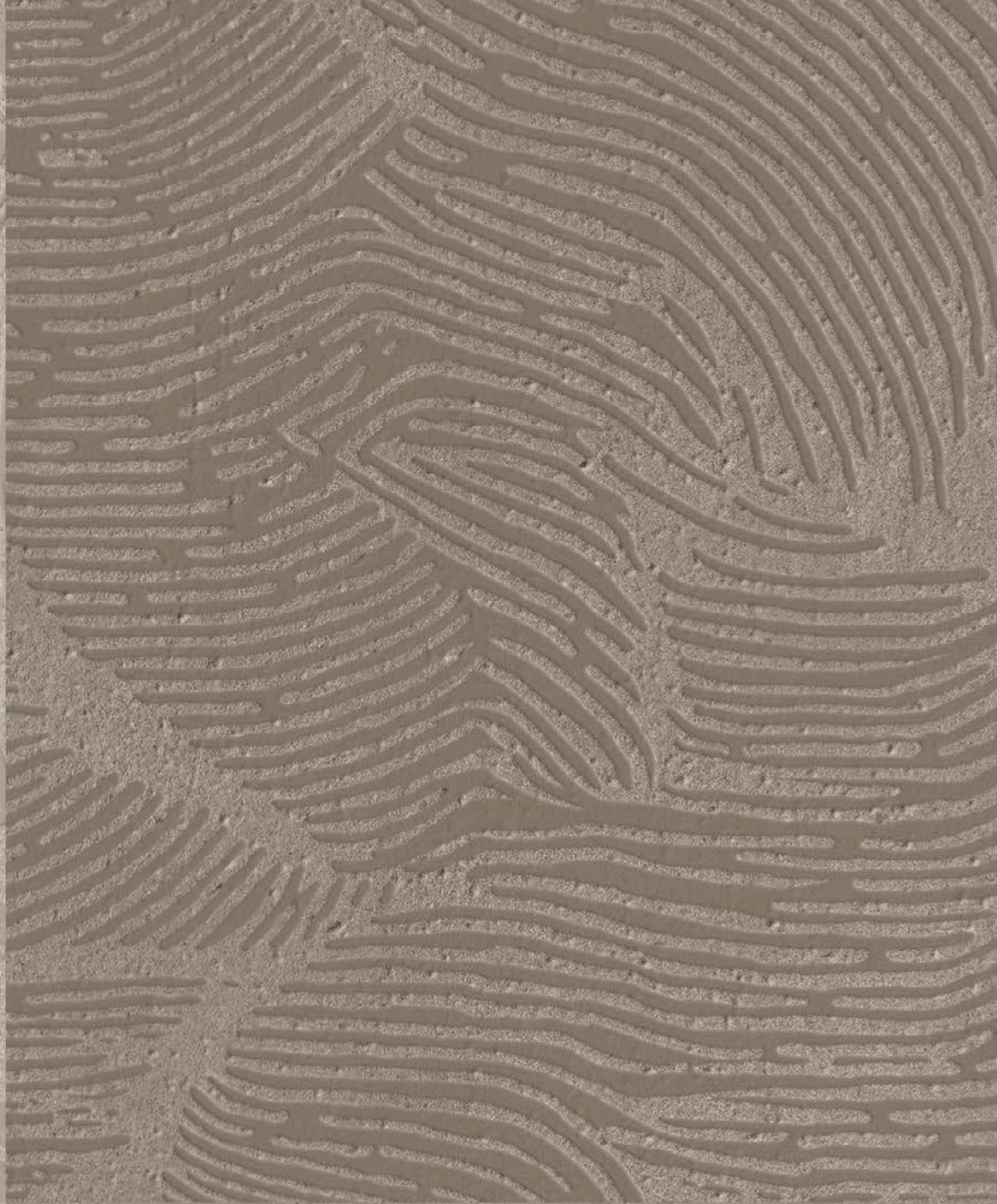

LINOVA

6 mm

120x280 - 48"x112"

9 mm

60x120 - 24"x48"

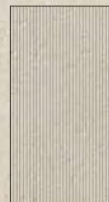

EDELIS

6 mm

120x280 - 48"x112"

9 mm

60x120 - 24"x48"



HARI

6 mm

120x280 - 48"x112"

9 mm

60x120 - 24"x48"





MOSAICO LISTELLATO

9 mm

15x120 - 6"x48"



MOSAICO MINI BAGUETTE 3D

9 mm

30x120 - 12"x48"



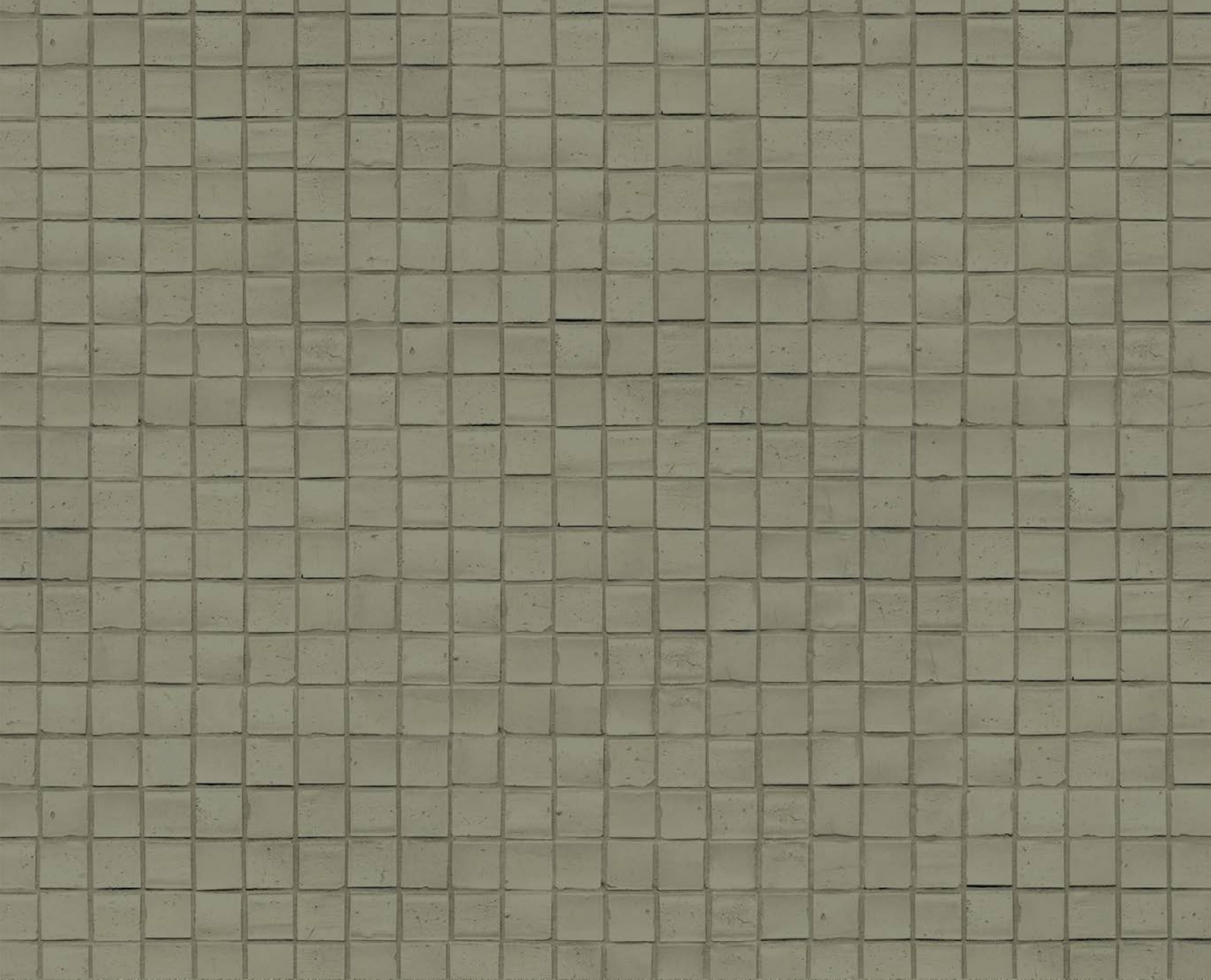
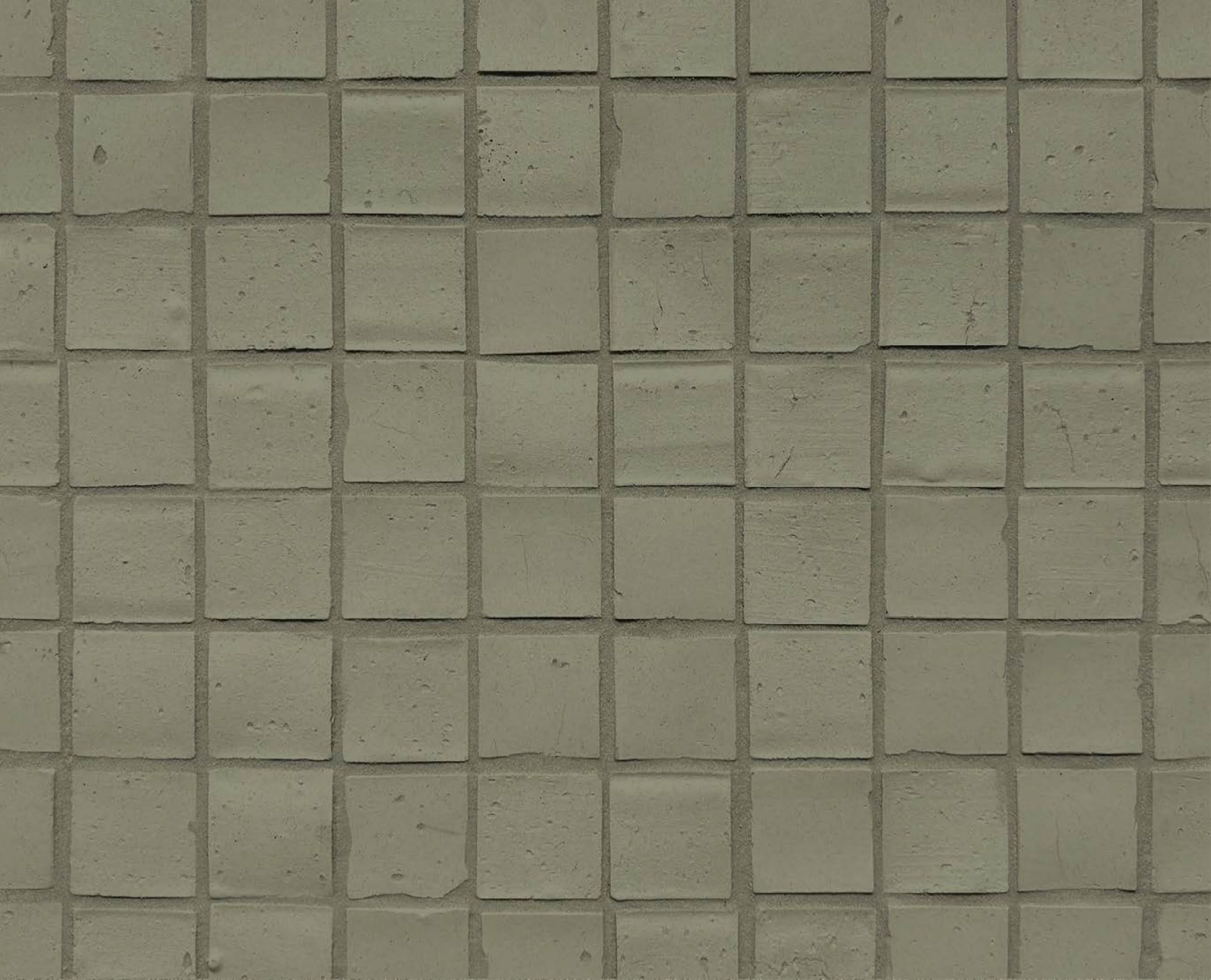

MOSAICO 3x3

3 mm

30x30 - 12"x12"
tessere 3x3



ECO MATERIA

Impasti di argille colorate ed elevate % di vetro riciclato
Coloured clay body mixes with high % of recycled glass



MOSAICO 1x1

4 mm

30x30 - 12"x12"
tessere 1x1

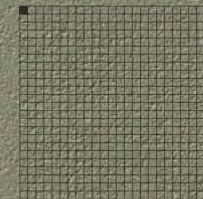

ECO MATERIA

Impasti di argille colorate ed elevate % di vetro riciclato
Coloured clay body mixes with high % of recycled glass



Beyond the Stoneware

Si allarga la proposta commerciale offerta da Kronos. Non ci limitiamo ad offrire i nuovi mobili rivestiti in gres, ma proponiamo anche soluzioni in legno laccato, disponibili in una gamma di colorazioni esclusive. Ogni tonalità è stata attentamente studiata per armonizzarsi alla perfezione con la palette cromatica della collezione Materia, garantendo la creazione di elementi unici, versatili e contemporanei.

Kronos has extended its commercial offering. No longer only offering our new stoneware-clad furniture, we now also have lacquered wood solutions in a range of exclusive colours. Each shade has been carefully chosen to harmonise perfectly with the Materia collection's colour range, creating unique, versatile, contemporary interior design features.

L'offre commerciale de Kronos s'élargit. Nous ne nous contentons pas d'offrir les nouveaux meubles en grès, mais nous proposons également des solutions en bois laqué, disponibles dans une gamme de coloris exclusifs. Chaque teinte a été soigneusement étudiée pour s'accorder parfaitement avec la palette couleur de la collection Materia, garantissant la création d'éléments uniques, polyvalents et contemporains.

Kronos erweitert sein Produktprogramm. Neben neuen mit Feinsteinzeug verkleideten Möbeln wartet der Hersteller auch mit Produkten aus lackiertem Holz in exklusiven Farben auf. Jeder Farbton wurde mit größter Sorgfalt passend zur Farbpalette der Kollektion Materia ausgewählt, was die Gestaltung von einzigartigen, vielseitigen und zeitgemäßen Einrichtungselementen ermöglicht.





**K-SAO
TORTORA**

Dimensione:
L 21 cm
P 12 cm
H 50 cm

Materiale:
Terracotta
semirefrettaria

Dimensions:
W 21 cm
D 12 cm
H 50 cm

Material:
Semi-refractory
terracotta



**K-CATO
CENERE**

Dimensione:
L 21,5 cm
P 12 cm
H 44 cm

Materiale:
Terracotta
semirefrettaria

Dimensions:
W 21,5 cm
D 12 cm
H 44 cm

Material:
Semi-refractory
terracotta



**K-GEO
SETA**

Dimensione:
L 17,5 cm
P 12,5 cm
H 36 cm

Materiale:
Terracotta
semirefrettaria

Dimensions:
W 17,5 cm
D 12,5 cm
H 44 cm

Material:
Semi-refractory
terracotta



**K-TA
SANDALO**

Dimensione:
L 22 cm
P 12 cm
H 46 cm

Materiale:
Terracotta
semirefrettaria

Dimensions:
W 22 cm
D 12 cm
H 46 cm

Material:
Semi-refractory
terracotta



**K-CARE
CEMENTO**

Dimensione:
L 19 cm
P 12 cm
H 41 cm

Materiale:
Terracotta
semirefrettaria

Dimensions:
W 19 cm
D 12 cm
H 41 cm

Material:
Semi-refractory
terracotta



**K-TOA
GESSO**

Dimensione:
L 24 cm
P 14 cm
H 45 cm

Materiale:
Terracotta
semirefrettaria

Dimensions:
W 24 cm
D 14 cm
H 45 cm

Material:
Semi-refractory
terracotta



**K-OLO
INCENSO**

Dimensione:
L 22 cm
P 12 cm
H 49 cm

Materiale:
Terracotta
semirefrettaria

Dimensions:
W 22 cm
D 12 cm
H 49 cm

Material:
Semi-refractory
terracotta



**K-PAO
OLIVA**

Dimensione:
L 21 cm
P 12 cm
H 55,5 cm

Materiale:
Terracotta
semirefrettaria

Dimensions:
W 21 cm
D 12 cm
H 55,5 cm

Material:
Semi-refractory
terracotta



**K-ESO
PESCA**

Dimensione:
L 23 cm
P 13 cm
H 37 cm

Materiale:
Terracotta
semirefrettaria

Dimensions:
W 23 cm
D 13 cm
H 37 cm

Material:
Semi-refractory
terracotta

MATERIA

ELEGANT . CONCRETE

KALLE STRIP LED

STRIPLED CABLATO COMPLETO DI ALIMENTATORE INTEGRATO 2700K
Wired led strip light complete with integral 2700 k transformer



KALLE STRIP LED

Strip led cablato completo di alimentatore integrato.
Wired LED strip light complete with integral transformer.

KALLE strip led 60 cm - 24"
KALLE strip led 90 cm - 36"
KALLE strip led 120 cm - 48"

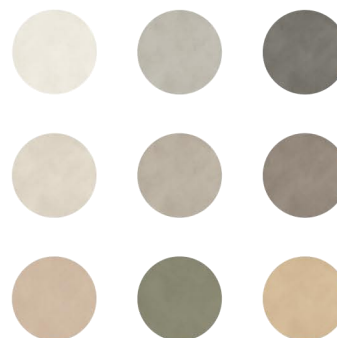
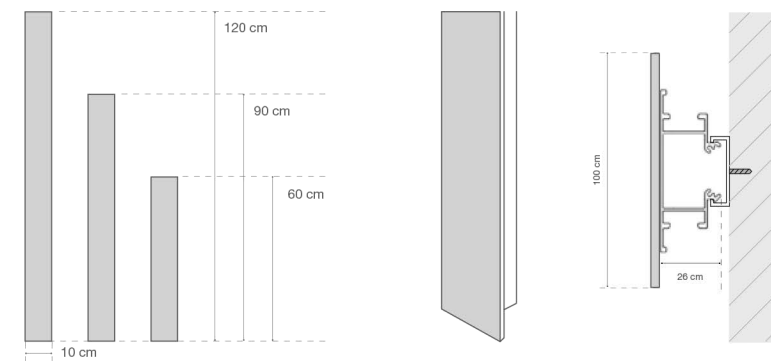

GESSO



6 mm

120x280 - 48"x112"

MA001 GESSO

120x120 - 48"x48"

MA016 GESSO

60x120 - 24"x48"

MA193 GESSO

9 mm

120x120 - 48"x48"

MA010 GESSO

120x120 - 48"x48"

MA070 GESSO GRIP

60x120 - 24"x48"

MA028 GESSO

60x120 - 24"x48"

MA088 GESSO GRIP

80x80 - 32"x32"

MA052 GESSO

80x80 - 32"x32"

MA058 GESSO GRIP

60x60 - 24"x24"

MA064 GESSO

SKE 2.0

20 mm

120x120 - 48"x48"

MA082 GESSO

60x120 - 24"x48"

MA037 GESSO

CEMENTO



6 mm

120x280 - 48"x112"

MA003 CEMENTO

120x120 - 48"x48"

MA018 CEMENTO

60x120 - 24"x48"

MA195 CEMENTO

9 mm

120x120 - 48"x48"

MA012 CEMENTO

120x120 - 48"x48"

MA072 CEMENTO GRIP

60x120 - 24"x48"

MA030 CEMENTO

60x120 - 24"x48"

MA090 CEMENTO GRIP

80x80 - 32"x32"

MA054 CEMENTO

80x80 - 32"x32"

MA060 CEMENTO GRIP

60x60 - 24"x24"

MA066 CEMENTO

SKE 2.0

20 mm

120x120 - 48"x48"

MA084 CEMENTO

60x120 - 24"x48"

MA039 CEMENTO

SANDALO



6 mm

120x280 - 48"x112"

MA005 SANDALO

120x120 - 48"x48"

MA020 SANDALO

60x120 - 24"x48"

MA197 SANDALO

9 mm

120x120 - 48"x48"

MA014 SANDALO

120x120 - 48"x48"

MA074 SANDALO GRIP

60x120 - 24"x48"

MA032 SANDALO

60x120 - 24"x48"

MA092 SANDALO GRIP

80x80 - 32"x32"

MA056 SANDALO

80x80 - 32"x32"

MA062 SANDALO GRIP

60x60 - 24"x24"

MA068 SANDALO

SKE 2.0

20 mm

120x120 - 48"x48"

MA086 SANDALO

60x120 - 24"x48"

MA041 SANDALO

SETA



6 mm

120x280 - 48"x112"

MA002 SETA

120x120 - 48"x48"

MA017 SETA

60x120 - 24"x48"

MA194 SETA

9 mm

120x120 - 48"x48"

MA011 SETA

120x120 - 48"x48"

MA071 SETA GRIP

60x120 - 24"x48"

MA029 SETA

60x120 - 24"x48"

MA089 SETA GRIP

80x80 - 32"x32"

MA053 SETA

80x80 - 32"x32"

MA059 SETA GRIP

60x60 - 24"x24"

MA065 SETA

SKE 2.0

20 mm

120x120 - 48"x48"

MA083 SETA

60x120 - 24"x48"

MA038 SETA

CENERE



6 mm

120x280 - 48"x112"

MA004 CENERE

120x120 - 48"x48"

MA019 CENERE

60x120 - 24"x48"

MA196 CENERE

9 mm

120x120 - 48"x48"

MA013 CENERE

120x120 - 48"x48"

MA073 CENERE GRIP

60x120 - 24"x48"

MA031 CENERE

60x120 - 24"x48"

MA091 CENERE GRIP

80x80 - 32"x32"

MA055 CENERE

80x80 - 32"x32"

MA061 CENERE GRIP

60x60 - 24"x24"

MA067 CENERE

SKE 2.0

20 mm

120x120 - 48"x48"

MA085 CENERE

60x120 - 24"x48"

MA040 CENERE

TORTORA



6 mm

120x280 - 48"x112"

MA006 TORTORA

120x120 - 48"x48"

MA021 TORTORA

60x120 - 24"x48"

MA198 TORTORA

9 mm

120x120 - 48"x48"

MA015 TORTORA

120x120 - 48"x48"

MA075 TORTORA GRIP

60x120 - 24"x48"

MA033 TORTORA

60x120 - 24"x48"

MA093 TORTORA GRIP

80x80 - 32"x32"

MA057 TORTORA

80x80 - 32"x32"

MA063 TORTORA GRIP

60x60 - 24"x24"

MA069 TORTORA

SKE 2.0

20 mm

120x120 - 48"x48"

MA087 TORTORA

60x120 - 24"x48"

MA042 TORTORA

PESCA



6 mm

120x280 - 48"x112"

MA008 PESCA

120x120 - 48"x48"

MA023 PESCA

60x120 - 24"x48"

MA200 PESCA

9 mm

120x120 - 48"x48"

MA035 PESCA

60x120 - 24"x48"

MA035 PESCA

60x120 - 24"x48"

MA035 PESCA

60x120 - 24"x48"

MA035 PESCA

60x120 - 24"x48"

MA035 PESCA

60x120 - 24"x48"

MA035 PESCA

60x120 - 24"x48"

MA035 PESCA

SKE 2.0

20 mm

120x120 - 48"x48"

MA035 PESCA

60x120 - 24"x48"

MA035 PESCA

OLIVA

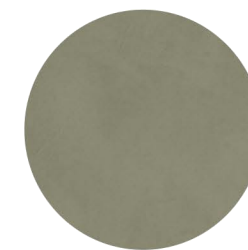

6 mm

120x280 - 48"x112"

MA009 OLIVA

120x120 - 48"x48"

MA024 OLIVA

60x120 - 24"x48"

MA201 OLIVA

9 mm

120x120 - 48"x48"

MA036 OLIVA

60x120 - 24"x48"

MA036 OLIVA

60x120 - 24"x48"

MA036 OLIVA

60x120 - 24"x48"

MA036 OLIVA

60x120 - 24"x48"

MA036 OLIVA

60x120 - 24"x48"

MA036 OLIVA

60x120 - 24"x48"

MA036 OLIVA

SKE 2.0

20 mm

120x120 - 48"x48"

MA036 OLIVA

60x120 - 24"x48"

MA036 OLIVA

INCENSO

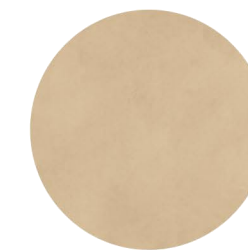

6 mm

120x280 - 48"x112"

MA007 INCENSO

120x120 - 48"x48"

MA022 INCENSO

60x120 - 24"x48"

MA199 INCENSO

9 mm

120x120 - 48"x48"

MA034 INCENSO

60x120 - 24"x48"

MA034 INCENSO

60x120 - 24"x48"

MA034 INCENSO

60x120 - 24"x48"

TRAMA

GESSO



9 mm

60x120 - 24"x48"

MA043 GESSO

CEMENTO

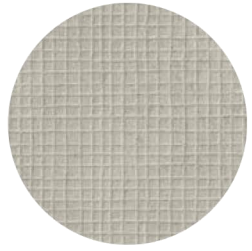

9 mm

60x120 - 24"x48"

MA045 CEMENTO

SANDALO

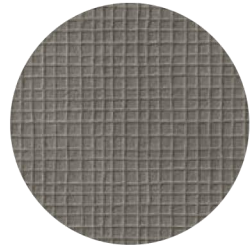

9 mm

60x120 - 24"x48"

MA047 SANDALO

SETA

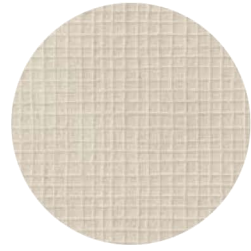

9 mm

60x120 - 24"x48"

MA044 SETA

CENERE

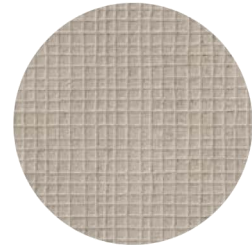

9 mm

60x120 - 24"x48"

MA046 CENERE

TORTORA

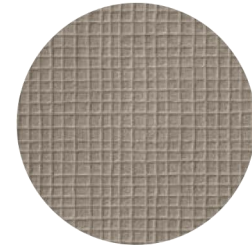

9 mm

60x120 - 24"x48"

MA048 TORTORA

PESCA

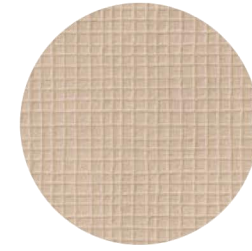

9 mm

60x120 - 24"x48"

MA050 PESCA

OLIVA

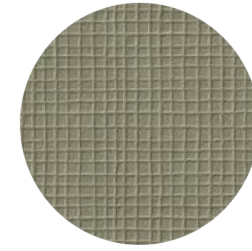

9 mm

60x120 - 24"x48"

MA051 OLIVA

INCENSO

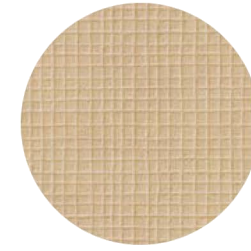

9 mm

60x120 - 24"x48"

MA049 INCENSO

EDELIS

GESSO



6 mm

120x280 - 48"x112"

MA130 GESSO

CEMENTO



6 mm

120x280 - 48"x112"

MA132 CEMENTO

SANDALO



6 mm

120x280 - 48"x112"

MA134 SANDALO

SETA



6 mm

120x280 - 48"x112"

MA131 SETA

CENERE



6 mm

120x280 - 48"x112"

MA133 CENERE

TORTORA



6 mm

120x280 - 48"x112"

MA135 TORTORA

PESCA



6 mm

120x280 - 48"x112"

MA137 PESCA

OLIVA



6 mm

120x280 - 48"x112"

MA138 OLIVA

INCENSO



6 mm

120x280 - 48"x112"

MA136 INCENSO

9 mm

60x120 - 24"x48"

MA139 GESSO

9 mm

60x120 - 24"x48"

MA141 CEMENTO

9 mm

60x120 - 24"x48"

MA143 SANDALO

9 mm

60x120 - 24"x48"

MA140 SETA

9 mm

60x120 - 24"x48"

MA142 CENERE

9 mm

60x120 - 24"x48"

MA144 TORTORA

9 mm

60x120 - 24"x48"

MA146 PESCA

9 mm

60x120 - 24"x48"

MA147 OLIVA

9 mm

60x120 - 24"x48"

MA145 INCENSO

HARI

GESSO



6 mm

120x280 - 48"x112"

MA148 GESSO

CEMENTO



6 mm

120x280 - 48"x112"

MA150 CEMENTO

SANDALO

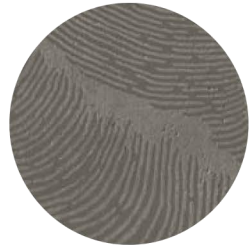

6 mm

120x280 - 48"x112"

MA152 SANDALO

SETA



6 mm

120x280 - 48"x112"

MA149 SETA

CENERE



6 mm

120x280 - 48"x112"

MA151 CENERE

TORTORA



6 mm

120x280 - 48"x112"

MA153 TORTORA

PESCA



6 mm

120x280 - 48"x112"

MA155 PESCA

OLIVA

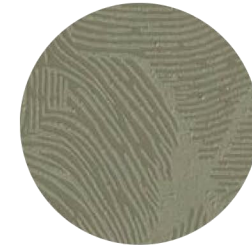

6 mm

120x280 - 48"x112"

MA156 OLIVA

INCENSO



6 mm

120x280 - 48"x112"

MA154 INCENSO

9 mm

60x120 - 24"x48"

MA157 GESSO

9 mm

60x120 - 24"x48"

MA159 CEMENTO

9 mm

60x120 - 24"x48"

MA161 SANDALO

9 mm

60x120 - 24"x48"

MA158 SETA

9 mm

60x120 - 24"x48"

MA160 CENERE

9 mm

60x120 - 24"x48"

MA162 TORTORA

9 mm

60x120 - 24"x48"

MA164 PESCA

9 mm

60x120 - 24"x48"

MA165 OLIVA

9 mm

60x120 - 24"x48"

MA163 INCENSO

LINOVA

GESSO



6 mm

120x280 - 48"x112"

MA166 GESSO

CEMENTO



6 mm

120x280 - 48"x112"

MA168 CEMENTO

SANDALO



6 mm

120x280 - 48"x112"

MA170 SANDALO

SETA



6 mm

120x280 - 48"x112"

MA167 SETA

CENERE



6 mm

120x280 - 48"x112"

MA169 CENERE

TORTORA

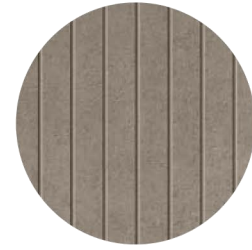

6 mm

120x280 - 48"x112"

MA171 TORTORA

PESCA

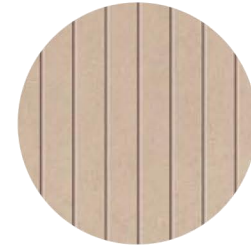

6 mm

120x280 - 48"x112"

MA173 PESCA

OLIVA



6 mm

120x280 - 48"x112"

MA174 OLIVA

INCENSO



6 mm

120x280 - 48"x112"

MA172 INCENSO

9 mm

60x120 - 24"x48"

MA094 GESSO

9 mm

60x120 - 24"x48"

MA096 CEMENTO

9 mm

60x120 - 24"x48"

MA098 SANDALO

9 mm

60x120 - 24"x48"

MA095 SETA

9 mm

60x120 - 24"x48"

MA097 CENERE

9 mm

60x120 - 24"x48"

MA099 TORTORA

9 mm

60x120 - 24"x48"

MA101 PESCA

9 mm

60x120 - 24"x48"

MA102 OLIVA

9 mm

60x120 - 24"x48"

MA100 INCENSO

MOSAICO MINI BAGUETTE 3D

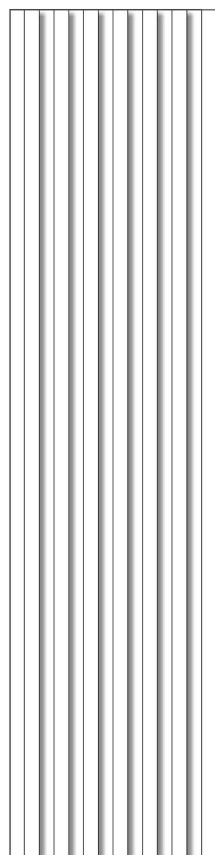

9 mm
30x120 - 12"x48"

MA103 GESSO
MA104 SETA
MA105 CEMENTO
MA106 CENERE
MA107 SANDALO
MA108 TORTORA
MA109 INCENSO
MA110 PESCA
MA111 OLIVA

MOSAICO LISTELLATO

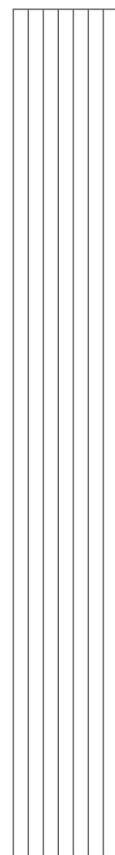

9 mm
15x120 - 6"x48"

MA112 GESSO
MA113 SETA
MA114 CEMENTO
MA115 CENERE
MA116 SANDALO
MA117 TORTORA
MA118 INCENSO
MA119 PESCA
MA120 OLIVA

MOSAICO 3x3

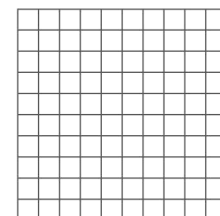

3 mm
30x30 - 12"x12"

MA202 GESSO
MA204 CEMENTO
MA206 SANDALO
MA203 SETA
MA205 CENERE
MA207 TORTORA
MA209 PESCA
MA208 INCENSO
MA210 OLIVA

MOSAICO 1x1

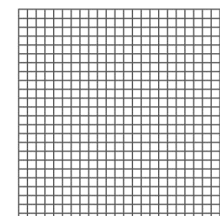

4 mm
30x30 - 12"x12"

MA121 GESSO
MA123 CEMENTO 24
MA125 SANDALO 24
MA122 SETA
MA124 CENERE 24
MA126 TORTORA
MA128 PESCA
MA127 INCENSO
MA129 OLIVA

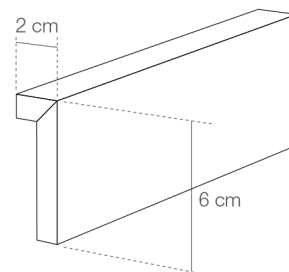

CLOSE
9 mm
6x60 - 2³/₈"x24"

MA211 GESSO
MA212 SETA
MA213 CEMENTO
MA214 CENERE
MA215 SANDALO
MA216 TORTORA
MA217 INCENSO
MA218 PESCA
MA219 OLIVA

BATTISCOPA
9 mm
4,6x60 - 1³/₄"x24"

MA175 GESSO
MA176 SETA
MA177 CEMENTO
MA178 CENERE
MA179 SANDALO
MA180 TORTORA

BATTISCOPA
9 mm
4,6x120 - 1³/₄"x48"

MA184 GESSO
MA185 SETA
MA186 CEMENTO
MA187 CENERE
MA188 SANDALO
MA189 TORTORA

IMBALLI_PACKAGING_EMBALLAGES_VERPACKUNGEN

MATERIA	Thickness	Pezzi per scatola	M ² per scatola	Kg per scatola	Scatole per pallet
120x280 - 48"x112"	6	1	3,36	47,4	20
120x120 - 48"x48"	6	2	2,88	41	24
60x120 - 24"x48"	6	3	2,16	32	30
120x120 - 48"x48"	9	2	2,88	67	20
120x120 - 48"x48" GRIP	9	2	2,88	67	20
60x120 - 24"x48"	9	2	1,44	27,9	30
60x120 - 24"x48" GRIP	9	2	1,44	27,9	30
80x80 - 32"x32"	9	2	1,28	24,8	40
80x80 - 32"x32" GRIP	9	2	1,28	24,8	40
60x60 - 24"x24"	9	3	1,08	21	40
SKE 2.0 120x120 - 48"x48"	20	1	1,44	67	18
SKE 2.0 60x120 - 24"x48"	20	1	0,72	33,4	30
Trama 60x120 - 24"x48"	9	2	1,44	27,9	30
Edelis 120x280 - 48"x112"	6	1	3,36	47,4	20
Edelis 60x120 - 24"x48"	9	2	1,44	27,9	30
Hari 120x280 - 48"x112"	6	1	3,36	47,4	20
Hari 60x120 - 24"x48"	9	2	1,44	27,9	30
Linova 120x280 - 48"x112"	6	1	3,36	47,4	20
Linova 60x120 - 24"x48"	9	2	1,44	27,9	30
Mosaico Mini Baguette 3D 30x120 - 12"x48"	9	2	0,72	14	10
Mosaico listellato 15x120 - 6"x48"	9	6	1,08	21	30
Mosaico Eco Materia 30x30 - 12"x12" Tessere 3x3	3	10	0,9	4,5	72
Mosaico Eco Materia 30x30 - 12"x12" Tessere 1x1	4	8	0,72	5	72
Battiscopa 4,6x60 - 1 ³ / ₄ "x24"	9	14	-	9,00	56
Battiscopa 4,6x120 - 1 ³ / ₄ "x48"	9	6	-	8,00	60
Close 6x60 - 2 ³ / ₈ "x24"	9	1	-	-	-

VARIAZIONE CROMATICA_SHADE VARIATION_VARIATION CHROMATIQUE_CHROMATISCHE ABWEICHUNG



V1
aspetto uniforme
uniform appearance
aspect uniforme
Gleichmäßiges Bild



V2
lieve variazione
slight variation
légère différence de nuance
Leichte Abweichung



V3
moderata variazione
moderate variation
variation modérée
Mäßige Abweichung



V4
forte variazione
substantial variation
variation intense
Stärke Abweichung

CARATTERISTICHE E PROPRIETÀ - CHARACTERISTICS OR PROPERTIES CARACTERISTIQUES OU PROPRIETES - EIGENSCHAFTEN UND GÜTEMERKMALE	NORME - STANDARDS NORMES - NORMEN	SECONDO LE NORME - COMPLIANCE WITH STANDARDS - CONFORME AUX NORMES - ENTSPRECHEND DEN NORMEN UNI EN 14411 G - GRUPPO BIA UGL				
			6 mm 120x280	6 mm	9 mm	9 mm GRIP SKE 2.0
RESISTENZA ALLE MACCHIE - RESISTANCE TO STAIN - RESISTANCE AUX TACHES FLECKENFESTIGKEIT	ISO 10545-14	VALORE DICHIARATO - DECLARED VALUE - VALEUR DECLAREE - ANGELEGEBENER WERT	CLASSE 5	CLASSE 5	CLASSE 5	CLASSE 5
RESISTENZA AGLI AGENTI CHIMICI - CHEMICAL RESISTANCE - RESISTANCE A L'ATTAQUE CHIMIQUE - BÄSTÄNDIGKEIT GEGEN CHEMIKALIEN	ISO 10545-13	UB MIN.	UA ULA	UA ULA	UA ULA UHA	UA ULA UHA
RESISTENZA ALLO SCIVOLAMENTO - SLIP RESISTANCE - RÉSISTANCE AU GLISSEMENT - BESTIMMUNG DER RUSTCHEMMENDE EIGENSCHAFT COEFFICIENTE D'ATTRITO - DYNAMIC COEFFICIENT OF FRICTION - COEFFICIENT DE FRICTION DYNAMIQUE - DYNAMISCHER REIBUNGSKOEFFIZIENT	DIN EN 16165: 2021 ANNEX B	-	R9	R10	R10	R11
	DIN EN 16165: 2021 ANNEX A	-	A	B	B	C
	BS-7976 PTV	≥ 36	-	COMPLIANT	COMPLIANT	COMPLIANT
	DCOF BOT 3000	WET ≥ 0,42	COMPLIANT	COMPLIANT	COMPLIANT	COMPLIANT
RESISTENZA ALLA FLESSIONE - BENDING STRENGTH - RESISTANCE À LA FLEXION - BIEGEZUGFESTIGKEIT	ISO 10545-4	≥ 35 N/mm²	52	52	54	9 mm 54 20 mm 49
SFORZO DI ROTTURA - BREAKING STRENGTH IN N - FORCE DE RUPTURE EN N - BRUCHLAST IN N	ISO 10545-4	≥ 700 N (sp < 7,5mm) ≥ 1300 N (sp ≥ 7,5mm)	1350	1350	2157	9 mm 2157 20 mm 11789
ASSORBIMENTO D'ACQUA - WATER ABSORPTION - ABSORPTION D'EAU - WASSERAUFNAHME	ISO 10545-3	≤ 0,5 %	AVERAGE VALUE 0,08%			
RESISTENZA ALL'ABRASIONE PROFONDA - RESISTANCE TO DEEP ABRASION RESISTANCE A L'ABRASION PROFONDE - WINDERSTÄNDSFAKIGKEIT GEGEN TIEFENABRIEB	ISO 10545-6	≤ 175 mm³	139	139	102	102 123
RESISTENZA AGLI SBALZI TERMICI - THERMAL SHOCK RESISTANCE - RESISTANCE AUX ECARTS THERMIQUES - TEMPERATURWECHSELBESTÄNDIGKEIT	ISO 10545-9	TEST SUPERATO SECONDO EN ISO 10545-1 - PASS ACCORDING EN ISO 10545-1 - TEST OBTENUS SELON EN ISO 10545-1 - TEST LAUT EN ISO 10545-1 BESTANDEN	NESSUN DANNO - NO DAMAGE - AUCUN DOMMAGE - KEIN SCHADEN			
QUALITÀ DELLA SUPERFICIE - SURFACE QUALITY - QUALITE DE LA SURFACE - OBERFLÄCHENQUALITÄT	ISO 10545-2	IL 95% MIN DELLE PISTRELLE DEVE ESSERE ESENTE DA DIFETTI VISIBILI - AT LEAST 95% OF THE TILE MUST BE FREE FROM VISIBLE FLAWS - 95% MIN DES CARREUX NE DOIVENT PRÉSENTER AUCUN DÉFAUT VISIBLE - MINDESTENS 95% DER FLIESEN MÜSSEN FREI VON SICHTBAREN	CONFORME ALLE NORME - COMPLIES WITH STANDARD - CONFORME AUX NORMES - NORMGERECHT			
DEVIAZIONE MASSIMA DI RETTILINEITÀ IN % - MAXIMUM STRAIGHTNESS DEVIATION IN % - MARGE DE TOLERANCE DE RECTITUDE EN % - ZULAESSIGE HOECHSTABWEICHUNG DER KANTENGERADHEIT IN PROZENTEN		± 0,5 % ± 1,5 mm	CONFORME ALLE NORME - COMPLIES WITH STANDARD - CONFORME AUX NORMES - NORMGERECHT			
DEVIAZIONE AMMISSIBILE IN %, DELLO SPESSORE MEDIO DI OGNI PIASTRELLA DALLA DIMENSIONE DI FABBRICAZIONE - ADMITTED DEVIATION, IN %, OF THE AVERAGE THICKNESS OF EACH TILE FROM THE PRODUCTION DIMENSIONS - MARGE DE TOLÉRANCE, EN POURCENTAGE, ENTRE L'ÉPAISSEUR MOYENNE DE CHAQUE CARREAU ET LA DIMENSION DE FABRICATION - ZULÄSSIGE ABWEICHUNG DER DURCHSCHNITTSDICKE JEDER FLIESE VOM HERSTELLMASS IN PROZENTEN		± 0,5 % ± 0,5 mm	CONFORME ALLE NORME - COMPLIES WITH STANDARD - CONFORME AUX NORMES - NORMGERECHT			
DEVIAZIONE MASSIMA DI ORTOGONALITÀ IN % - MAXIMUM RIGHT-ANGLE DEVIATION IN % - MARGE DE TOLERANCE D'ANGULARITE IN % - HOECHSTABWEICHUNG DER RECHTWINKLIGKEIT IN PROZENTEN		± 0,5 % ± 2,0 mm	CONFORME ALLE NORME - COMPLIES WITH STANDARD - CONFORME AUX NORMES - NORMGERECHT			
PLANARITÀ - FLATNESS - PLANEITE - EBENFLÄCHIGKEIT		± 0,5 % ± 2,0 mm	CONFORME ALLE NORME - COMPLIES WITH STANDARD - CONFORME AUX NORMES - NORMGERECHT			
LUNGHEZZA E LARGHEZZA - LENGTH AND WIDTH - LONGUEUR ET LARGEUR - LÄNGE UND BREITE		± 0,6 % ± 2,0 mm	CONFORME ALLE NORME - COMPLIES WITH STANDARD - CONFORME AUX NORMES - NORMGERECHT			
RESISTENZA AL GELO - FROST RESISTANCE - RESISTANCE AU GEL - FROSTBESTÄNDIGKEIT	ISO 10545-12	TEST SUPERATO SECONDO EN ISO 10545-1 - PASS ACCORDING EN ISO 10545-1 - TEST OBTENUS SELON EN ISO 10545-1 - TEST LAUT EN ISO 10545-1 BESTANDEN	NESSUN DANNO - NO DAMAGE - AUCUN DOMMAGE - KEIN SCHADEN			
RILASCIO DI SOSTANZE PERICOLOSE - RELEASE OF HAZARDOUS SUBSTANCES REJET DE SUBSTANCES DANGEREUSES - FREISETZUNG GEFÄHRLICHER STOFFE	DM-1-2-2007- Reg-CE 193-2004	VALORE DICHIARATO - DECLARED VALUE - VALEUR DECLAREE - ANGELEGEBENER WERT	CONFORME ALLE NORME, NO VARIAZIONI - COMPLIES WITH STANDARD, NO VARIATION - CONFORME AUX NORMES, PAS DE CHANGEMENTS - NORMGERECHT, KEINE ÄENDERUNG			
SKE2.0						
CARICO STATICO - STATIC LOAD - CHARGE STATIQUE - STATISCHER BELASTUNG	EN 12825	VALORE DICHIARATO - DECLARED VALUE - VALEUR DECLAREE - ANGELEGEBENER WERT	CENTRO 9,6 KN - CENTRE 9,6 KN CENTRO LATO 6,5 KN - CENTRE POINT OF SIDES 6,5 KN DIAGONALE 8,19 KN - DIAGONAL 8,19 KN (CLASSE 3)			
CARICO DINAMICO, PROVA DI URTO DI CORPI DURI - DYMANIC LAOD CAPACITY, HAND OBJECT IMPACT TEST - C. STATIQUE, ESSAI DE CHOC DE CORPS DURS - STATISCHER BELASTUNG, AUSWIRKUNGEN TEST DER HARTEN KÖRPER	EN 12825	VALORE DICHIARATO - DECLARED VALUE - VALEUR DECLAREE - ANGELEGEBENER WERT	TEST NON SUPERATO - TEST NOT PASSED TEST A ECHOUE - TEST FEHLGESCHLAGEN			
CARICO DINAMICO, PROVA DI URTO DI CORPI MORBIDI - DYMANIC LAOD CAPACITY, SOFT OBJECT IMPACT TEST C. STATIQUE, ESSAIS D'IMPACT DE CORPS MOUS - TATISCHER BELASTUNG, AUSWIRKUNGEN PRÜFUNG VON WEICHEN KÖRPERN	EN 12825	VALORE DICHIARATO - DECLARED VALUE - VALEUR DECLAREE - ANGELEGEBENER WERT	TEST SUPERATO - TEST PASSED TEST REUSSI - TEST BESTANDEN			
RESISTENZA ALLA FLESSIONE, CARICO DI ROTTURA IN N - BENDIND STRENGTH, BREAKING FORCE IN N - RÉSISTANCE À LA LFEXION, CHARGE DE ROPTURE IN N - BIEGEFESTIGKEIT, BRUCHLAST EN N	EN 1339	-	CLASSE U 14 KN 14,38			
CARICO DI ROTTURA IN MPA - BREAKING FORCE IN MPA - CHARGE DE ROPTURE IN MPA - BRUCHLAST EN MPA		-	MPA 46,5			